

— Karta Produktu

- Aktualizacja 05.01.2023
- Firma LABRA Sp. z o.o. rezerwuje sobie prawo do zmiany wykonania, materiałów i charakterystyki produktu bez wcześniejszej informacji. Technika oświetleniowa zmienia się bardzo szybko.
- Zdjęcia ukazują przykładowy wygląd produktu, wygląd produktu może się różnić w zależności od koloru, modelu, wybranej optyki itp. Wszystkie dane mają charakter informacyjny.

Dane Techniczne

- Zasilanie **230V 50/60 Hz**
- Zasilacz **Wbudowany**
- Żywotność źródła **50.000h L90**
- Gwarancja **5 lat**



Źródło światła (tylko LED) wymienne przez profesjonalistę.
Osprzęt sterujący wymienny przez profesjonalistę.

RAY EVO SET

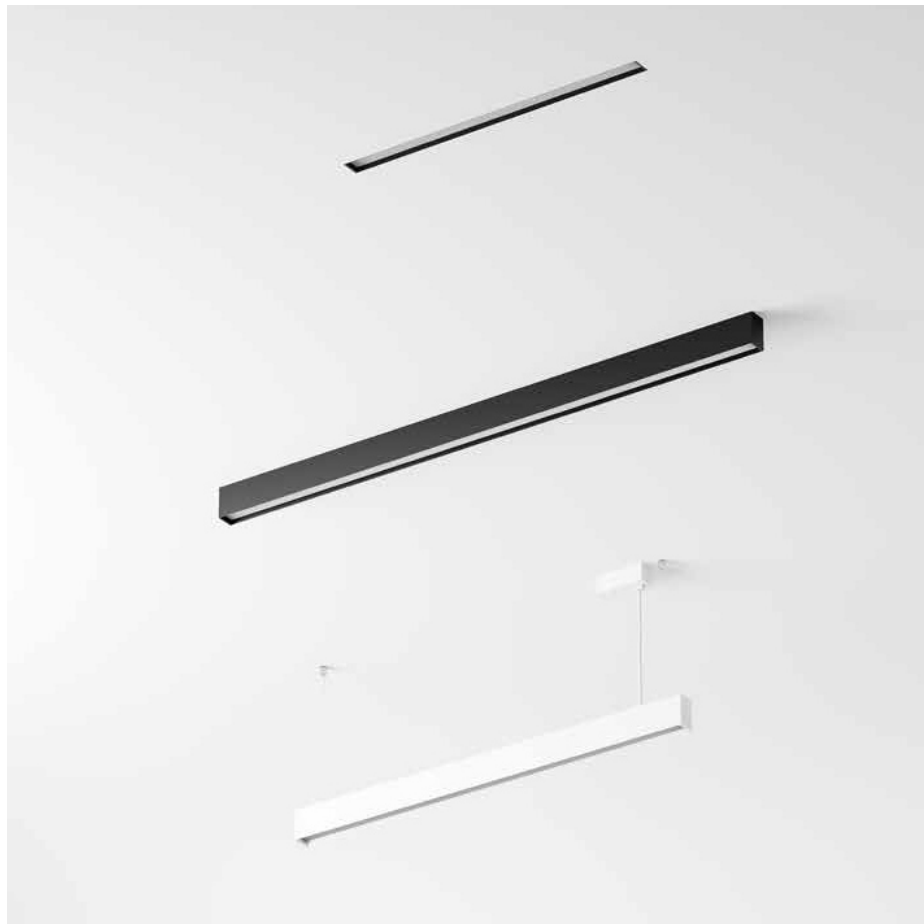

Model		On-Off	Switch DIM	DALI2		Czarny	Biały	Mixed	CR190 2700K	CR190 3000K	CR190 4000K	Opal / Rozproszone	Mikropryzma
						.02	.03	.99	.927	.930	.940	.DF	.MP
Ray Evo Set NT — Lightline ⊕													
1	Lightline 590 LP	14W 690lm	3.3404	3.3405	3.3406	•	•	•	•	•	•	•	•
	Lightline 870 LP	20W 1040lm	3.3407	3.3408	3.3409	•	•	•	•	•	•	•	•
	Lightline 1150 LP	27W 1390lm	3.3410	3.3411	3.3412	•	•	•	•	•	•	•	•
	Lightline 1430 LP	33W 1730lm	3.3413	3.3414	3.3415	•	•	•	•	•	•	•	•
	Lightline 590 HP	27W 1280lm	3.3416	3.3417	3.3418	•	•	•	•	•	•	•	•
	Lightline 870 HP	39W 1920lm	3.3419	3.3420	3.3421	•	•	•	•	•	•	•	•
	Lightline 1150 HP	53W 2560lm	3.3422	3.3423	3.3424	•	•	•	•	•	•	•	•
	Lightline 1430 HP	65W 3200lm	3.3425	3.3426	3.3427	•	•	•	•	•	•	•	•
Ray Evo Set WP — Lightline ⊕													
1	Lightline 590 LP	14W 690lm	4.3440	4.3441	4.3442	•	•	•	•	•	•	•	•
	Lightline 870 LP	20W 1040lm	4.3443	4.3444	4.3445	•	•	•	•	•	•	•	•
	Lightline 1150 LP	27W 1390lm	4.3446	4.3447	4.3448	•	•	•	•	•	•	•	•
	Lightline 1430 LP	33W 1730lm	4.3449	4.3450	4.3451	•	•	•	•	•	•	•	•
	Lightline 590 HP	27W 1280lm	4.3452	4.3453	4.3454	•	•	•	•	•	•	•	•
	Lightline 870 HP	39W 1920lm	4.3455	4.3456	4.3457	•	•	•	•	•	•	•	•
	Lightline 1150 HP	53W 2560lm	4.3458	4.3459	4.3460	•	•	•	•	•	•	•	•
	Lightline 1430 HP	65W 3200lm	4.3461	4.3462	4.3463	•	•	•	•	•	•	•	•
Ray Evo Set ZW — Lightline ⊕													
1	Lightline 590 LP	14W 690lm	5.3476	5.3477	5.3478	•	•	•	•	•	•	•	•
	Lightline 870 LP	20W 1040lm	5.3479	5.3480	5.3481	•	•	•	•	•	•	•	•
	Lightline 1150 LP	27W 1390lm	5.3482	5.3483	5.3484	•	•	•	•	•	•	•	•
	Lightline 1430 LP	33W 1730lm	5.3485	5.3486	5.3487	•	•	•	•	•	•	•	•
	Lightline 590 HP	27W 1280lm	5.3488	5.3489	5.3490	•	•	•	•	•	•	•	•
	Lightline 870 HP	39W 1920lm	5.3491	5.3492	5.3493	•	•	•	•	•	•	•	•
	Lightline 1150 HP	53W 2560lm	5.3494	5.3495	5.3496	•	•	•	•	•	•	•	•
	Lightline 1430 HP	65W 3200lm	5.3497	5.3498	5.3499	•	•	•	•	•	•	•	•
Ray Evo Set NT — Shift In ⊕													
1	Shift In 590	19W 1400lm, 47°	3.3428	3.3429	3.3430	•	•	•	•	•	•	•	•
	Shift In 870	27W 2100lm, 47°	3.3431	3.3432	3.3433	•	•	•	•	•	•	•	•
	Shift In 1150	36W 2800lm, 47°	3.3434	3.3435	3.3436	•	•	•	•	•	•	•	•
	Shift In 1430	44W 3500lm, 47°	3.3437	3.3438	3.3439	•	•	•	•	•	•	•	•
Ray Evo Set WP — Shift In ⊕													
1	Shift In 590	19W 1400lm, 47°	4.3464	4.3465	4.3466	•	•	•	•	•	•	•	•
	Shift In 870	27W 2100lm, 47°	4.3467	4.3468	4.3469	•	•	•	•	•	•	•	•
	Shift In 1150	36W 2800lm, 47°	4.3470	4.3471	4.3472	•	•	•	•	•	•	•	•
	Shift In 1430	44W 3500lm, 47°	4.3473	4.3474	4.3475	•	•	•	•	•	•	•	•
Ray Evo Set ZW — Shift In ⊕													
1	Shift In 590	19W 1400lm, 47°	5.3500	5.3501	5.3502	•	•	•	•	•	•	•	•
	Shift In 870	27W 2100lm, 47°	5.3503	5.3504	5.3505	•	•	•	•	•	•	•	•
	Shift In 1150	36W 2800lm, 47°	5.3506	5.3507	5.3508	•	•	•	•	•	•	•	•
	Shift In 1430	44W 3500lm, 47°	5.3509	5.3510	5.3511	•	•	•	•	•	•	•	•

Ray Evo Set Lightline NT

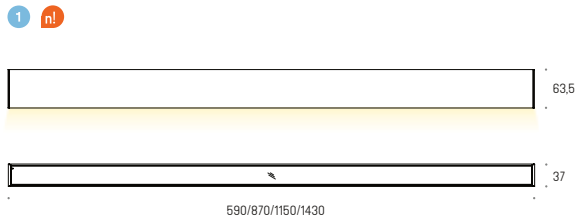

Ray Evo Set Shift In NT

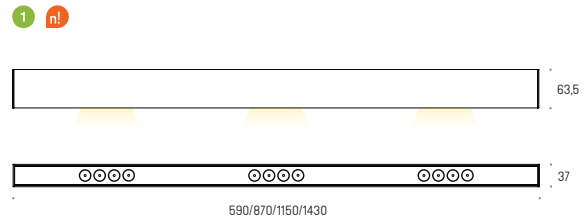

Ray Evo Set Lightline WP

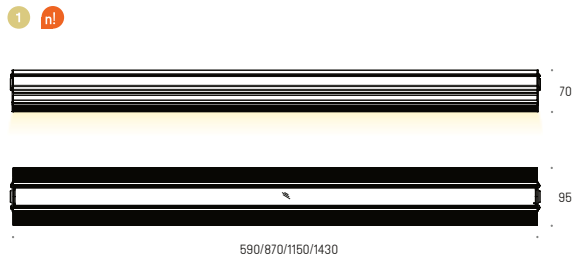

Ray Evo Set Shift In WP

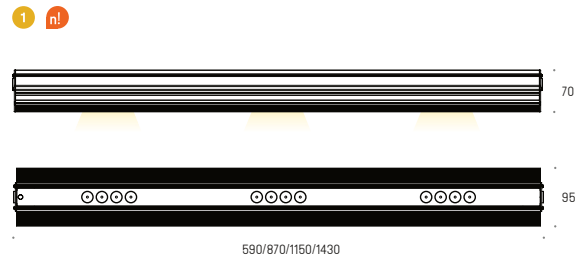

Ray Evo Set Lightline ZW

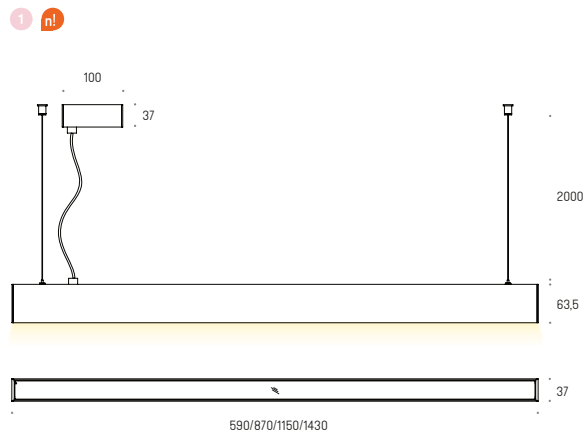

Ray Evo Set Shift In ZW

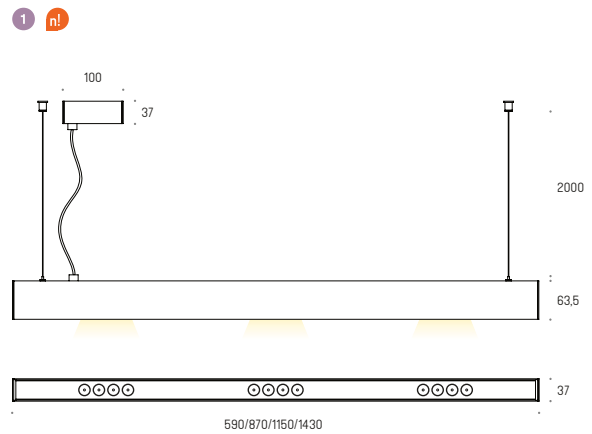

Shift In — Rozłożenie optyk zależnie od długości — wszystkie wersje

